

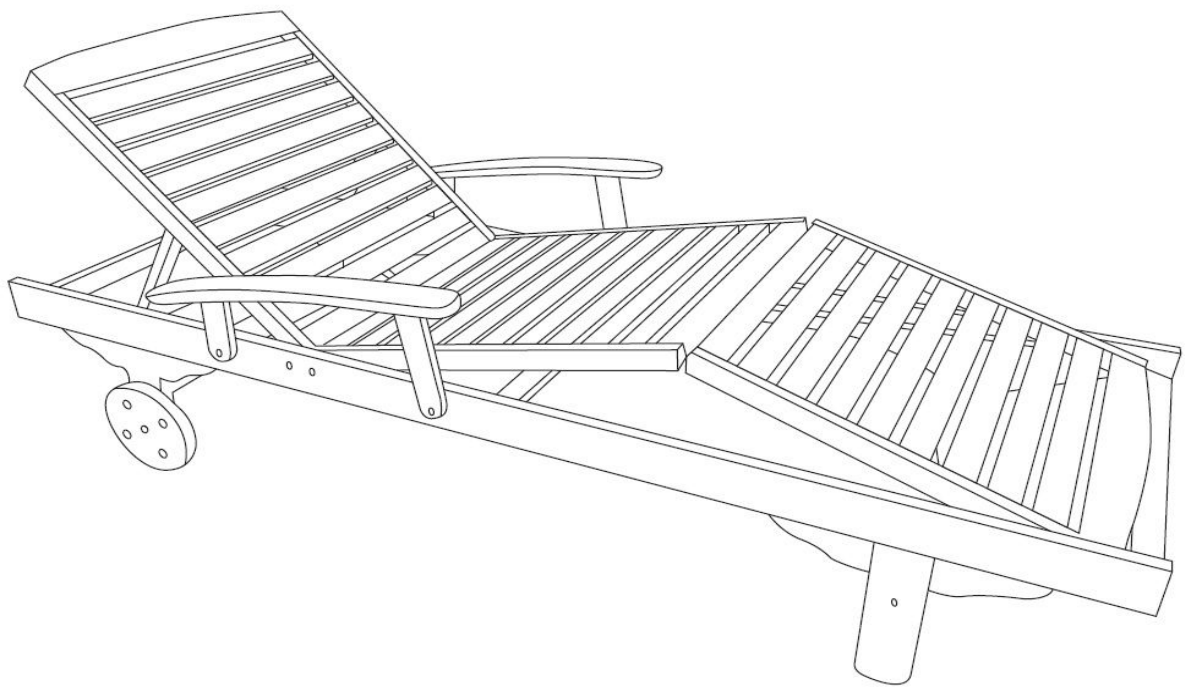

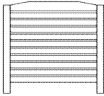

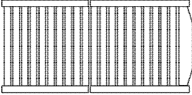

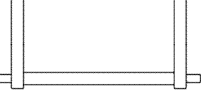

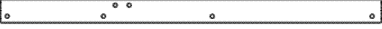
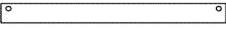
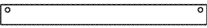
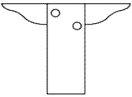
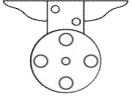

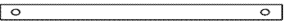
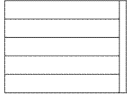





Singapour

1063_68297



1063_68297

A.		765mm x 578mm	x 1	1/1
B.		1140mm x 578mm	x 1	1/1
C.		610mm x 250mm	x 1	1/1
D.		1820mm x 90mm	x 2	1/1
E.		608mm x 44mm	x 3	1/1
F.		608mm x 35mm	x 1	1/1
G.		370mm x 280mm	x 2	1/1
H.		370mm x 280mm	x 2	1/1
I.		608mm x 60mm	x 2	1/1
J.		582mm x 35mm	x 2	1/1
K.		330mm x 240mm	x 1	1/1
L.		575mm x 315mm	x 2	1/1

1063_68297				
M.		M6 x 35mm	x 4	1/1
N.		M6 x 40mm	x 2	1/1
O.		M6 x 45mm	x 8	1/1
P.		M6 x 50mm	x 8	1/1
Q.		M6 x 55mm	x 2	1/1
R.		M6 x 55mm	x 12	1/1
S.		M13	x 4	1/1
T.		M19	x 8	1/1
U.			x 6	1/1
V.			x 1	1/1
W.			x 1	1/1
X.			x 1	1/1

FR : SAV/INFORMATION /VIDEO/CONTACT

EN: AFTER-SALES SERVICE/INFORMATION/VIDEO/CONTACT

DE : REPARATUR-SERVICE UND ERSATZTEILE /INFORMATIONEN /VIDEO/KONTAKT

ES: SERVICIO POST-VENTA/INFORMACIÓN/VIDEO/CONTACTO

IT: SERVIZIO ASSISTENZA/INFORMAZIONI/VIDEO/CONTATTO

PT: SERVIÇO PÓS-VENDA/INFORMAÇÕES/VIDEO/CONTATO

PL: SERWIS TECHNICZNY/INFORMACJE/WIDEO/KONTAKT

NE: AFTER SALES SERVICE/INFORMATIE/VIDEO/CONTACT

HE: לאחר שירות ומכירות/מידע/הווידיאו/לתקשר עם

SAV.HABITATETJARDIN.COM

FR

- Il est conseillé d'attendre d'avoir monté entièrement votre produit avant de serrer complètement vos vis.
- En hiver, stockez dans un endroit abrité et sec
- Ne jamais utiliser des produits chimiques ou l'huile de lin pour le nettoyage.
- Evitez les chocs.
- Il est conseillé de protéger vos produits à l'aide d'une housse de protection afin de les préserver des intempéries et de la poussière.
- Il est déconseillé de laisser votre table en soleil avec le plateau en verre.

EN

- It is advisable to wait until you have fully assembled your product before tightening your screws completely.
- In winter, store your products in a dry place.
- It is advisable to put your products into cover to protect them from the severe weather and dust.
- Never use chemical products or linseed oil for cleaning.
- Avoid shocks
- It is not advisable to leave your table in the sun with the glass tray.

DE

- Es ist ratsam, für Ihre vollständig montiert zu warten, bevor vollständig Ihre Schrauben festziehen.
- Im Winter, speichern Sie Ihre Waren an einem trockenen Ort.
- Verwenden Sie niemals Chemikalien zur Reinigung.
- Vermeiden Sie Schock.
- Es wird empfohlen, Ihre Produkte mit einer Schutzabdeckung zum Schutz vor Witterung und Staub zu schützen.
- Es ist nicht ratsam, Sonnentisch mit Glasplatte zu verlassen.

ES

- Se aconseja montar totalmente el producto antes de apretar completamente todos los tornillos.
- En invierno, almacene los productos en un lugar seco.
- Nunca utilice productos químicos o aceite de lino para la limpieza.
- Evite los golpes.
- Se aconseja cubrir los productos con una funda para protegerlos de las intemperies y del polvo.
- Nunca cubra la mesa con una placa de vidrio.

IT

- È consigliato di aspettare di avere montato interamente il prodotto prima di stringere completamente le viti.
- Durante l'inverno, mettere i prodotti al riparo in un luogo secco.
- Mai usare prodotti chimici o l'olio di lino per pulire i prodotti
- Evitare gli shock.
- È consigliato di proteggere i prodotti con un sacco di protezione per preservarli dal brutto tempo e dalla polvere.
- Mai mettere il vassoio di vetro sopra il tavolo.

